



# Rolling shutters and rolling grilles

NEW: Air inlet control AC72 for smoke extraction concepts with industrial doors

**HÖRMANN**









- 4 Hörmann brand quality
- 6 Sustainably produced
- 7 Simple and sustainable planning
- 8 Good reasons to try Hörmann
- 12 Application areas
  
- 14 Rolling shutter / rolling grille SB  
Underground garage rolling shutter / rolling grille TGT
- 26 Rolling shutter / rolling grille DD
- 32 Rolling shutter / rolling grille combination with SSG DD
- 36 Rolling shutter DD S6
- 40 Rolling shutter laths
- 42 Rolling grille curtains
- 43 Shop doors
- 44 Wind lock and break-in resistance
- 46 Side doors
- 48 Colours
- 50 Safety features and performance characteristics
- 51 Compatible system solutions
- 52 Controls
- 56 Accessories
- 64 Performance characteristics
  
- 66 Hörmann product range

Copyright: No part or excerpt may be reproduced without our prior permission.  
Subject to changes. The doors shown are example applications – no guarantee.

Image on left: Stuecki Shoppingcenter Basel

# Hörmann brand quality

Reliable and oriented towards the future



Kirow Ardelt GmbH, Leipzig

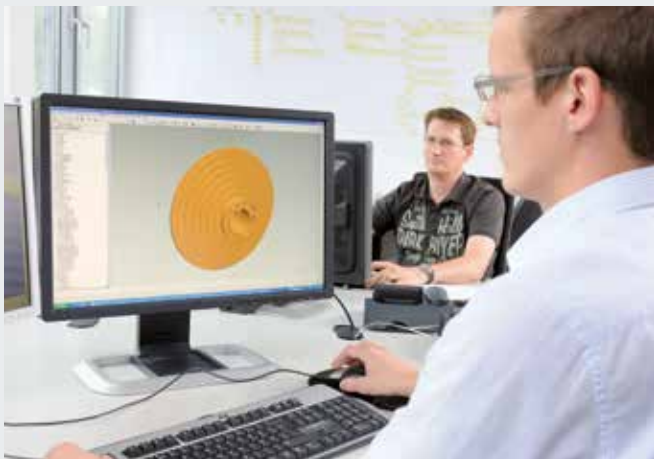

## In-house product development

At Hörmann, innovation is produced in-house – highly qualified employees of the development department are in charge of product optimisation and new developments. This results in market-ready, high-quality products that are very popular around the globe.



## Modern manufacturing

All the essential door components, such as profiles, side guides, and support brackets are developed and produced by Hörmann – not bought in from here, there and everywhere. This guarantees a high degree of compatibility between the door, operator and controls. The certified Management System guarantees the highest level of quality from development, through production to shipping. **This is Hörmann quality – Made in Germany.**





**Made in Germany**



As Europe's leading manufacturer of doors, hinged doors, frames and operators, we are committed to high product and service quality. This is how we set standards on an international scale.

Highly specialised factories develop and manufacture construction components that are characterised by excellent quality, functional safety and a long service life.

Our presence in the global economy's key regions makes us a strong, future-oriented partner for industrial and public construction projects.



It goes without saying that spare parts for doors, operators and controls are original Hörmann parts that come with a guaranteed availability of 10 years.



### Competent advice

Experienced specialists within our customer-oriented sales organisation accompany you from the planning stage, through technical clarification up to the final building inspection. Complete working documentation, such as, e.g. technical manuals, is not only available in printed form, but is always accessible and up-to-date at [www.hoermann.com](http://www.hoermann.com).



### Fast service

Our extensive service network means that we are always nearby and at your service around the clock. This is a great advantage for testing, maintenance and repairs.

# Sustainably produced

## For future-oriented construction



### **Sustainability documented and approved by the ift in Rosenheim**

Hörmann has received confirmation of the sustainability of all its rolling shutters and rolling grilles through an environmental product declaration (EPD) in accordance with ISO 14025 and EN 15804 from the Institut für Fenstertechnik (ift – Institute of window technology) in Rosenheim. The inspection was based on the Product Category Rules (PCR) “Doors and Gates”. Environmentally-friendly production was confirmed by a life-cycle analysis in accordance with DIN ISO 14040 / 14044 for all rolling shutters and rolling grilles.

### **Sustainably produced rolling shutters and rolling grilles from Hörmann**

#### **Ecological quality**

Environmentally-friendly production through a comprehensive energy management system

#### **Economical quality**

A long service life and low maintenance costs thanks to the use of high-quality materials

#### **Process quality**

Sustainable production processes through optimised material use

### **Sustainable construction with Hörmann's expertise**

Hörmann has been able to gain great expertise in sustainable construction through various projects. We also apply this know-how to support your projects.



# Simple and sustainable planning

With the Hörmann Architects' Program and energy savings compass



## The Architects' Program

More than 9000 drawings for over 850 products

Planning with Hörmann products is now even easier thanks to a modern, user-friendly interface. Clearly structured navigation via drop-down menus and symbols, as well as a search function, provide faster access to texts for invitation to tenders and drawings (in DWG and PDF format) of over 850 Hörmann products. **In addition, BIM data can be provided for many products for the Building Information Modelling process, enabling efficient planning, drafting, construction and management of buildings.** Photos and photo-realistic presentations provide additional information on many products.



The Architects' Program is available to you as a web version at [www.hoermann.co.uk/forums/architects-forum/architects-program](http://www.hoermann.co.uk/forums/architects-forum/architects-program) or can be downloaded free-of-charge from the Hörmann Architects' Forum.

## The energy savings compass for sustainable planning

Hörmann's energy savings compass shows how industrial door systems and loading technology are planned with energy-efficiency and sustainability in mind. An integrated calculation module estimates the amortisation period for door and loading technology systems.

The energy savings compass is available as a web-based interface for PC / MAC and mobile end devices.



Plan with the energy savings compass at:  
[https://www.hoermann.co.uk/fileadmin/\\_country/UK/Energiesparkompass/Energy\\_savings\\_compass/ml\\_eskSCALEframe.html](https://www.hoermann.co.uk/fileadmin/_country/UK/Energiesparkompass/Energy_savings_compass/ml_eskSCALEframe.html)



We are a member of the professional association for digital building products in the Federal Association of Building Systems e.V.

# Good reasons to try Hörmann

The market leader has all the innovations

**Only from Hörmann**



## 1 Innovative tension spring assembly

All rolling shutters / rolling grilles SB and underground garage rolling shutters / rolling grilles TGT are equipped with tension spring assembly. Thanks to this technology the door opens and closes particularly easily and the **door and operator mechanism is protected**. The custom-dimensioned springs enable long service intervals.

For further information, see pages 16 – 17.

## 2 Easy manual operation

Rolling shutters / rolling grilles SB can be **easily** opened and closed **by hand** as the weight of the door curtain is compensated thanks to the tension spring assembly. This **inexpensive solution** is ideal for doors that are rarely used. If the frequency of the door use changes, an electric operator can be easily retrofitted.

For further information, see pages 18 – 19.





# 3

## High safety

Thanks to the **standard power limit** of operators WA 300 R S4 and WA 300 AR S4, the rolling shutters / rolling grilles SB and TGT offer **particularly high safety during opening and closing**. For many curtain variants and size ranges, the installation of a closing edge and lintel trap guard can therefore be dispensed with.

For further information, see page 17.



# 4

## Particularly easy to fit and service

**All door components are supplied ready to install** so that no adjustments or drill holes have to be performed on-site. The fixing points are prepared for all components on-site. **This is how doors can be fitted easily and without errors in the shortest amount of time.** This reduces fitting times and costs.

For further information, see page 17.

# Good reasons to try Hörmann

The market leader has all the innovations



# 5

## Specifically for collective garages

The underground garage rolling shutters / rolling grilles TGT were developed to meet the **special requirements of underground and collective garages**. The **compact design** with low required headroom allows for an installation even in very tight spaces. In combination with the standard soft start and soft stop function of the operators, the doors are particularly characterised by their **smooth running** characteristics.

For further information, see pages 22 – 25.



# 6

## Quick door opening

Optimise your operations and minimise heat loss **with the optional accessory package S6 for the rolling shutter DD** with Decotherm curtain. The door opens **at up to 1.1 m/s – and thus almost as fast as a high-speed door**. Fitting dimensions as well as procurement and operating costs are significantly lower than for a high-speed door. Thanks to the soft start and soft stop function, the door runs particularly gently – this takes stress off the door mechanism, **thus extending the service life of the door**. A light grille in the travel area ensures high safety and is also reliably protected against damage.

For further information, see pages 36 – 39.





# 7

## Rolling shutter / rolling grille combination

With the SSG DD you can combine up to 3 doors with a movable mullion and thus close **door openings of up to 36 m width and 9 m height**. The standard rolling shutters / rolling grilles can be operated individually or simultaneously. In order to release the complete openings, the coupling elements are simply pushed to the side. The rolling shutter / rolling grille combination with SSG DD is a **particularly economical solution** – from transport and fitting to service.

For further information, see pages 32 – 35.

# 8

## Long service life

**All rolling shutter / rolling grille components are designed to have a long service life.** For this purpose, the support brackets and barrels are supplied galvanized as standard and the side guides are made of high-quality aluminium. **Long-lasting components are used down to the last detail.** For example, the well thought-out design of the guide channel with particularly wide sliding surfaces on the rolling shutter DD, which also reduces wear of the door curtain.

For further information, see page 29.

# Application areas

A matching door type for every purpose

## Compact and space-saving night door for shopping centres

Rolling shutter /  
rolling grille SB  
Rolling shutter /  
rolling grille DD

You can find additional door solutions  
for store entrances on page 43.



## Optimised door systems for logistics

Rolling shutter SB  
Rolling shutter DD  
Rolling shutter DD S6



## Easy operation for commercial buildings, warehouses and agriculture

Rolling shutter SB  
(manually operated)  
Rolling shutter SB  
(with operator)





## Secure night door for collective garages and multi-storey car parks

Rolling shutter /  
rolling grille TGT

Rolling shutter /  
rolling grille DD

You can find additional door solutions for underground and collective garages in the "Door systems for collective garages" brochure.



## Economic design for industrial and production halls

Rolling shutter /  
rolling grille SB

Rolling shutter /  
rolling grille DD



## Ideal solution for large openings up to 36 m width and 9 m height

Rolling shutter /  
rolling grille DD  
with SSG DD



## Rolling shutter / rolling grille SB

The economic door solution with tension spring assembly, either manually operated or power-driven



The manual rolling shutter allows for a **simple operation** of doors up to 5000 × 4500 mm.





The **convenient operation via operator** is the best solution for doors with a high opening frequency.



This **robust, inexpensive solution** with steel or aluminium rolling shutter curtains is available for door widths up to 5000 mm.



This door features space-saving design and high operational safety in all situations, e.g. with emergency opening from the outside, which is **especially suited for store entrances without a separate entrance**.

**Rolling shutter / rolling grille SB  
and underground garage rolling shutter / rolling grille TGT**  
With tension spring assembly for comfort and safety





With tension  
spring assembly



1



2



3

## Safe and reliable thanks to innovative tension spring assembly 1

The rolling shutters / rolling grilles SB and TGT are characterised by a **low-maintenance and economical** operation, as the curtain weight is ideally compensated by the tension spring assembly. For manually operated doors, the tension spring assembly provides support during **easy opening and closing of the door**. For power-driven doors, the tension spring assembly reduces operator load and **extends the service life of operator components**.

## Well thought-out door construction

The entire door construction, including support brackets and side guides, is fitted as a frame unit to the building structure. This reduces fitting time and thus costs. Thanks to the optional fitting gearbox **2**, fitting is also possible in difficult fitting situations without a forklift. Thanks to the low sideroom of only 165 mm, the door can also be fitted **easily** in tight spaces. Plastic runners and brushes in the aluminium side guides ensure **quiet door travel**.



See the fitting video at:  
[www.hormann.co.uk/videos](http://www.hormann.co.uk/videos)

## Operator variants as standard with soft start and soft stop as well as power limit 3

The standard power limit in the “Open” and “Close” directions **ensures safe operation, as the door stops reliably when encountering an obstacle. In addition, it is particularly easy to fit**, because most curtains and door sizes do not require a closing edge safety device and lintel trap guard at the door. Due to the lack of sensors with a wear-prone spiral cable on the door curtain, this door / operator construction is also very **low-maintenance and cost-effective**. Thanks to the soft start and soft stop function of the door curtain, all door and operator components are protected from wear.

### Impulse operation without closing edge safety device

- Size range for rolling shutters SB Decotherm S and rolling grilles SB HG-L
- Size range for rolling grille TGT HG-L

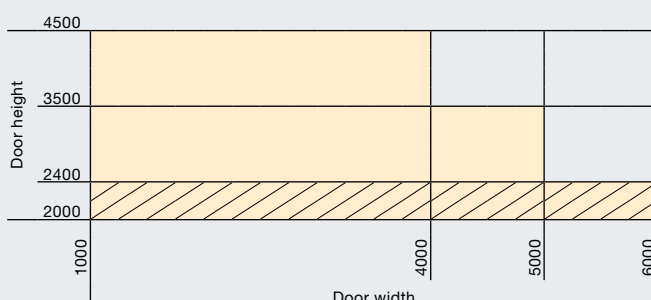

All details in mm

# Rolling shutter / rolling grille SB

## The economic solution for manual opening and closing

### Manually operated door solution

The manually operated rolling shutter / rolling grille SB is the optimum solution for low-frequency building openings and allows for easy opening and closing even without an operator.

### Simple operation

Thanks to the patented tension spring assembly, the door can be opened and closed manually with very little effort. The door is operated via the interior or exterior handle or optionally via a pull rod or a chain hoist.

### Optional operator retrofitting

If an automatic door opening is subsequently required, an operator can be easily retrofitted to the rolling shutter / rolling grille SB (see page 21).

### Maximum door sizes

Rolling shutter up to 5000 × 4500 mm

Rolling grille up to 6000 × 4500 mm



1



2



5

### Curtain variants rolling shutter / rolling grille SB

Size range (W × H, max.)

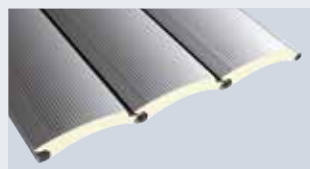

**Decotherm S, steel**  
5000 × 4500 mm

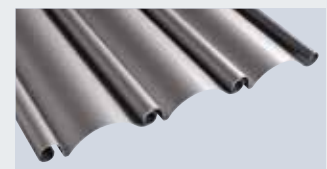

**HR 120 A, aluminium**  
5000 × 4500 mm

All curtains with wind locks or pull-out protection as standard!  
For further information, see page 45.

Curtain overview from page 40





### Actuation types

- Interior handle **1**
- Exterior handle **2**
- Pull rod (optional) **3**
- Chain hoist (optional) **4**

### Break-in-resistant locks

- Shootbolt **5**
- Lockable bottom profile **6**



Viewed from outside



Viewed from inside

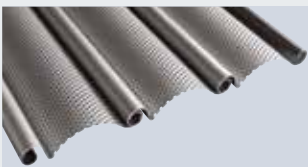

**HR 120 aero, aluminium**  
4000 × 4000 mm



**HG-L, aluminium**  
6000 × 4500 mm

# Rolling shutter / rolling grille SB

The convenient solution with optimally matched operators



## Tailored operator and control systems

The rolling shutter / rolling grille SB can also be equipped with an electric operator for particularly convenient door operation. These operator and control systems, which are optimally matched to the door technology, are characterised by the standard soft start and soft stop function of the door curtain, which protects all door and operator components from wear.

## Reliable power limit

With the operators WA 300 R S4 and WA 300 AR S4, you also benefit from the standard power limit in the "Open" and "Close" directions, which means that no additional safety systems such as closing edge safety devices and lintel trap guards are required for most curtains and door sizes. In the event of emergency operation, e.g. during a power failure, all operators can simply be switched to manual operation.

## Optional cover

For effective protection against accidental reaching into the door barrel as well as against dirt and adverse effects of the weather, optional cladding is available for the door barrel and operator **5**.

## Maximum door sizes

Rolling shutter up to 5000 × 4500 mm  
Rolling grille up to 6000 × 4500 mm



## Curtain variants rolling shutter / rolling grille SB

Size range (W × H, max.)

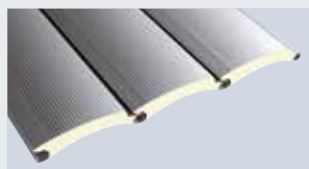

**Decotherm S, steel**  
5000 × 4500 mm



**HR 120 A, aluminium**  
5000 × 4500 mm

All curtains with wind locks or pull-out protection as standard!  
For further information, see page 45.

Curtain overview from page 40





2



5



6

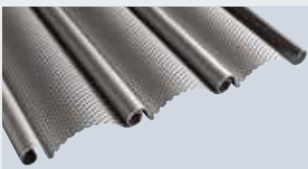

**HR 120 aero, aluminium**  
4000 × 4000 mm



**HG-L, aluminium**  
6000 × 4500 mm

## Operator variants

### 1 WA 250 R S4

#### The inexpensive operator with press-and-hold operation

- Ideally suited for doors with low operating frequency
- Opening and closing when button is pressed (press-and-hold operation)
- Integrated operator control with push button DTH-R 3
- Limit switch reporting or start warning with traffic lights can be optionally connected via additional prints

### 1 WA 300 R S4

#### The convenient operator with impulse operation

- Automatic opening and closing after pressing the button (impulse operation)
- Integrated operator control with push button DTH-R 3
- Automatic timer closing can be selected after 30, 60 or 90 seconds
- Low power consumption in standby of approx. 1 watt (if no other electrical accessories are connected)
- Functional extension possible with external control 360 (see page 52): second opening height, traffic control (in combination with activating kit for warning light and photocell)

### 2 WA 300 AR S4

#### The compact and convenient operator with impulse operation

- Ideally suited for fitting situations with suspended ceiling (stores, etc.), as no operator components are fitted beneath the door barrel
- Only 100 mm additional sideroom is required on the operator side
- Automatic opening and closing after pressing the button (impulse operation)
- Control unit 300 4 can be installed separately
- Quick and convenient setting of the travel limits and control parameters from the floor
- Automatic timer closing can be selected after 30, 60 or 90 seconds
- Low power consumption in standby of approx. 1 watt (if no other electrical accessories are connected)
- Functional extension possible with external control 360 (see page 52): second opening height, traffic control (in combination with activating kit for warning light and photocell)
- Activating emergency operation via standard "secured release" next to the side guide 6
- For indoor and outdoor use

## Underground garage rolling shutter / rolling grille TGT

The compact door solution for collective garages  
thanks to quiet door travel and wear-free safety technology

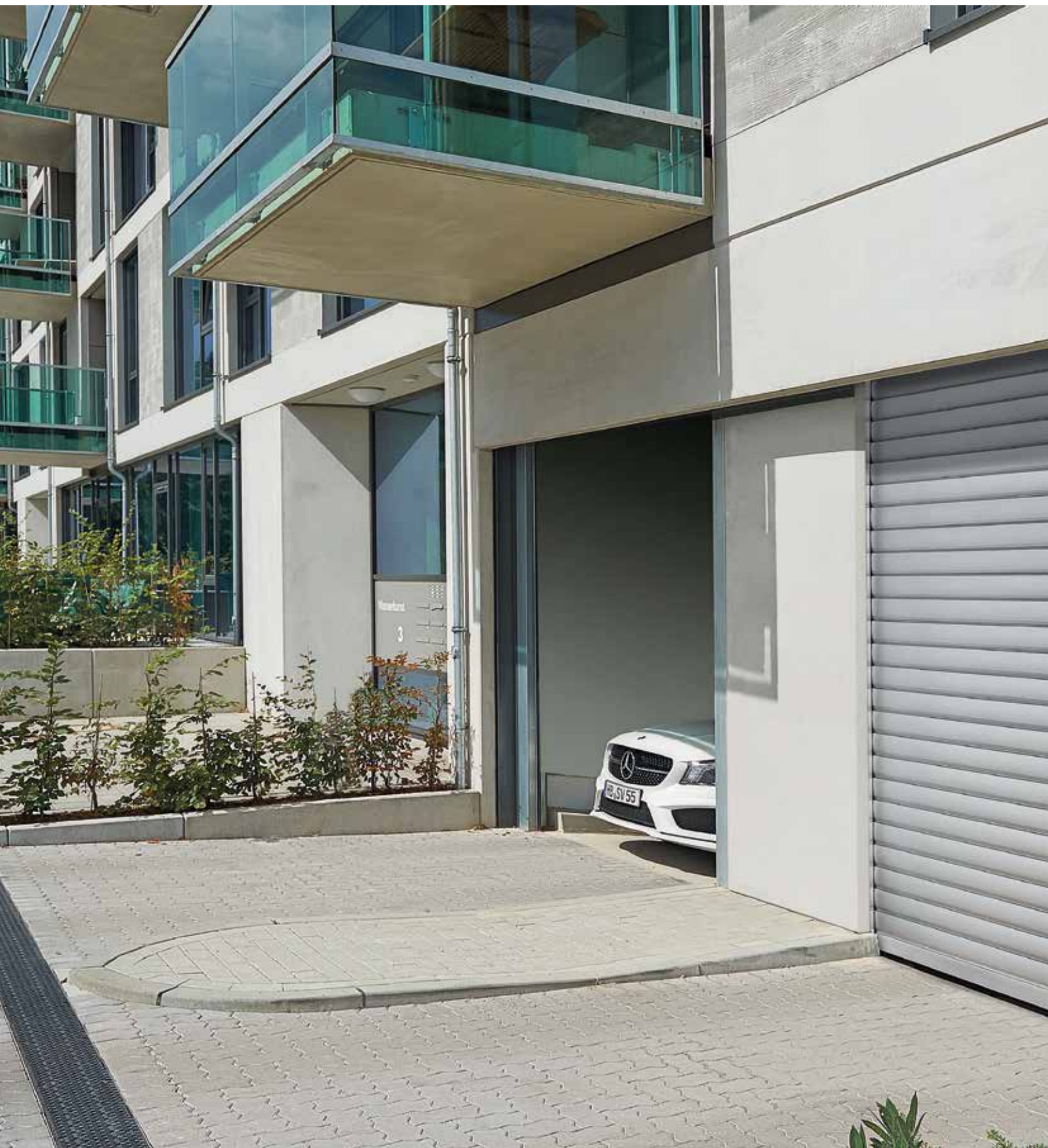

The **compact construction** is ideal for fitting situations with limited space.





Thanks to the standard soft start and soft stop function and the barrel-optimised profile technology, the underground garage rolling shutter / rolling grille is particularly smooth-running.



The standard power limit offers a high level of safety when opening and closing without sensors on the door curtain which are prone to malfunctions (underground garage rolling grille TGT with WA 300 AR S4 shown).



# Underground garage rolling shutter / rolling grille TGT

The compact door solution for collective garages thanks to quiet door travel and wear-free safety technology



## Compact design

The door construction specifically developed for the requirements of underground and collective garages with standard curtain cover is designed for an overall service life of 200000 door cycles\* (Open / Close). Due to this compact design, the rolling grille, for example, features a required headroom of only 350 mm. For further information, please see page 17.

## Optimised operator systems

The operators, which are designed for 300 door cycles (Open / Close) per day, are particularly smooth-running. Due to the standard power limit in "Open" and "Close" directions, no safety systems susceptible to wear have to be fitted, e.g. closing edge safety devices and lintel trap guards for impulse operation. In the event of malfunctions, the underground garage rolling shutter / rolling grille TGT can be opened quickly and easily by hand.

## Permanent protection

The galvanized sheet steel claddings **1** **2** are fitted directly to the door construction and protect the operator as well as the curtain. The optional 640 mm high marten protection **3** on the rolling grille TGT keeps litter and small animals out. With all versions, the spring chambers at the side guides can be closed with robust aluminium covers **4** in order to prevent accidental reaching into the door barrel.

## Maximum door sizes

Rolling shutter up to 5000 × 2400 mm  
Rolling grille up to 6000 × 2400 mm

\* With regular maintenance replacement of wearing parts, e.g. springs



## Curtain variants rolling shutter / rolling grille TGT

Size range (W × H, max.)

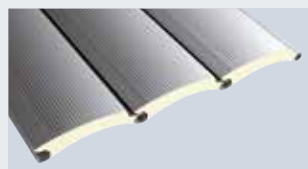

**Decotherm S, steel**  
5000 × 2400 mm



**HG-L, aluminium**  
6000 × 2400 mm

All curtains with wind locks or pull-out protection as standard!  
For further information, see page 45.

Curtain overview from page 40

**2**

**4**

**5**

## Operator variants

### WA 300 AR S4 **1**

#### The compact and convenient operator with impulse operation

- Ideally suited for fitting situations with driveways in front of the door, as no operator components are fitted beneath the door barrel
- Only 100 mm additional sideroom is required on the operator side
- Automatic opening and closing after pressing the button (impulse operation)
- Control unit 300 can be installed separately
- Quick and convenient setting of the travel limits and control parameters from the floor
- Automatic timer closing can be selected after 30, 60 or 90 seconds
- Low power consumption in standby of approx. 1 watt (if no other electrical accessories are connected)
- Functional extension possible with external control 360 (see page 52): second opening height, traffic control (in combination with activating kit for warning light and photocell)

### WA 300 R S4 **2**

#### The convenient operator with impulse operation

- Automatic opening and closing after pressing the button (impulse operation)
- Low power consumption in standby of approx. 1 watt (if no other electrical accessories are connected)
- Automatic timer closing can be selected after 30, 60 or 90 seconds
- Integrated operator control with push button DTH-R
- Functional extension with external control 360 (see page 52): second opening height, traffic control (in combination with activating kit for warning light and photocell)

## Emergency release **5**

- Easy and quick manual door opening
- Use of entrances and exits ensured even during power failures
- Optionally with tensioning system or operated from the exterior of the building

## Rolling shutter / rolling grille DD

Innovative rolling shutter generation  
for door openings up to a width of 12000 mm and a height of 9000 mm



The **robust construction** is suitable for industry, trade and commerce.





Thanks to the combination of multiple rolling shutters / rolling grilles DD with movable mullions SSG DD, **openings up to a width of 36 m and height of 9 m** can be closed.



The rolling grille DD is the ideal choice for **secure night doors** of large openings.

# Rolling shutter / rolling grille DD

Small fitting dimensions and convenient fitting





### Narrow aluminium side guide

The side guides require a sideroom of only 80 mm for all door sizes **1**. They are fitted quickly and easily directly to the building structure. For better handling during transport and fitting, the side guides are delivered as a 2-part version from a door height of 6000 mm. The support profiles made of aluminium **2** form an elegant unit with the side guides. The optional steel bracket fastening **3** allows fitting to insulated building openings or fitting by welding in steel construction.



### Compact support brackets

The support brackets only require a sideroom of max. 180 mm (bearing side) or max. 280 mm (operator side).

### Minimum wear guide channel

The standard guide channel with polyamide sliding surfaces **4** reduces wear of the door curtain. In case of maintenance, the metal holder can be replaced in a particularly service-friendly way.



### Easy fitting

The door construction is supplied as a ready-to-fit unit consisting of curtain, barrel and support bracket. The door components can easily be positioned on the building structure using the metre line and console template. Side guide markings ensure quick adjustment of the door's end-of-travel positions. The stackable packaging units also optimise transport and logistics to the construction site.



See the fitting video at:  
[www.hormann.co.uk/videos](http://www.hormann.co.uk/videos)



# Rolling shutter / rolling grille DD

More flexibility and simple fitting with the direct drive operator

## Powerful operator and control system

This door solution for medium to large openings is characterised by a powerful direct drive operator and variable operator fitting as standard.

## Flexible fitting

The fitting position of the operator can be freely selected during fitting and thus optimally adapted to the respective fitting situation on-site.

## Optional cladding

An optional curtain and operator cover is available for effective protection against dirt and adverse effects of the weather.

## Maximum door sizes

Rolling shutter up to 12000 × 9000 mm  
Rolling grille up to 12000 × 8000 mm



## Curtain variant rolling shutter DD

Size range (W × H, max.)

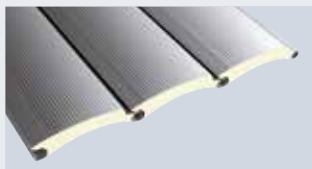

**Decotherm S, steel**  
12000 × 9000 mm

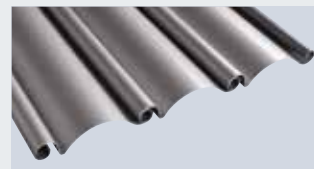

**HR 120 A, aluminium;**  
12000 × 8000 mm



**HG-L, aluminium**  
9000 × 5500 mm



**HG-V, aluminium (reinforced);  
HG-S, steel**  
12000 × 8000 mm



## Direct drive operator

- Powerful direct drive operator with absolute encoder (AWG) for a reliable door operation
- Integrated position-independent catch safety device prevents the door curtain from falling
- Variable operator fitting
  - 1 Towards bottom
  - 2 Horizontal
  - 3 Towards top
- With the horizontal or upward alignment, no operator technology is visible underneath the barrel



## Curtain and operator cover

- Protection of the door barrel from dirt and adverse effects of the weather with curtain cover PVDD 4
- Trap guard for doors less than 2500 mm high (required according to EN 13241-1)
- Can be extended by the VDD operator cover (closed unit: support brackets, curtain and operator) 5
- Made of galvanized sheet steel
- Quick and easy fitting thanks to fitting to door brackets

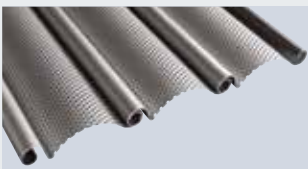

All curtains with wind locks or pull-out protection as standard!  
 Door versions for increased wind loads on request.  
 For further information, see page 45.

Curtain overview from page 40

**HR 120 aero, aluminium**  
 12000 × 8000 mm

# Rolling shutter / rolling grille combination SSG DD

For large openings of up to 36 m width and 9 m height



## Airports

Large openings are closed conveniently and efficiently by coupling two or three standard rolling shutters DD.



## Variable door openings

The doors can also be opened individually so that the opening can also be done in segments.





**Complete door opening**

For complete opening, the doors are opened and then the mullion SSG DD is unlocked and pushed to the side.

# Rolling shutter / rolling grille combination SSG DD

For large openings of up to 36 m width and 9 m height

## Economical combination

This door combination allows for particularly large openings to be closed conveniently and economically by coupling two or three standard rolling shutters DD or rolling grilles DD. This door combination is especially economical during transport, fitting and service.

## Variable door openings

For complete opening, the doors are opened and then the mullion SSG DD is unlocked and pushed to the side. The doors can also be opened independently so that the opening can also be done in segments.

## Higher wind loads

By locking the coupling elements on the building lintel and in the hall floor, this combination solution can withstand significantly higher wind loads compared to a large individual door.

## Maximum opening sizes

- Widths up to 36 m
- Heights up to 9 m

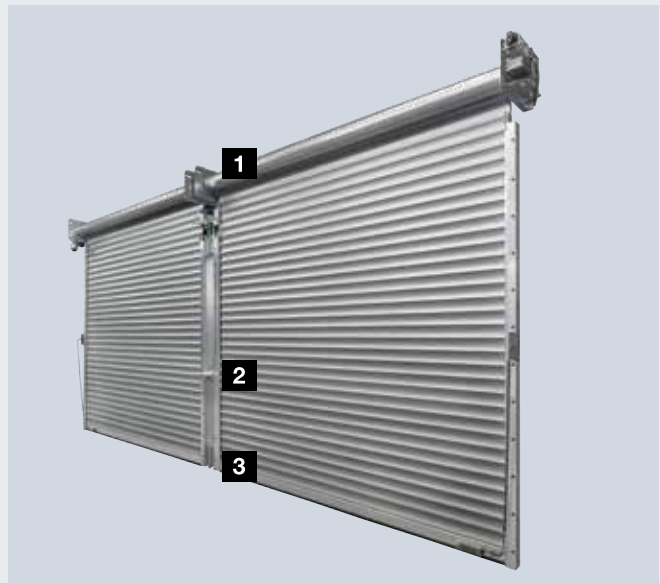

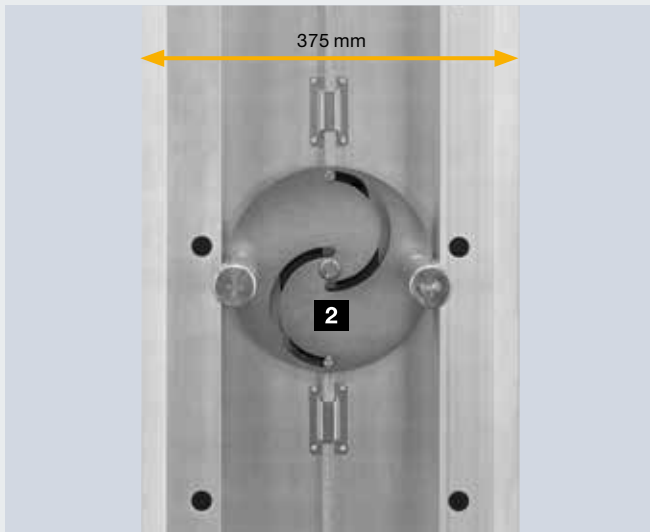
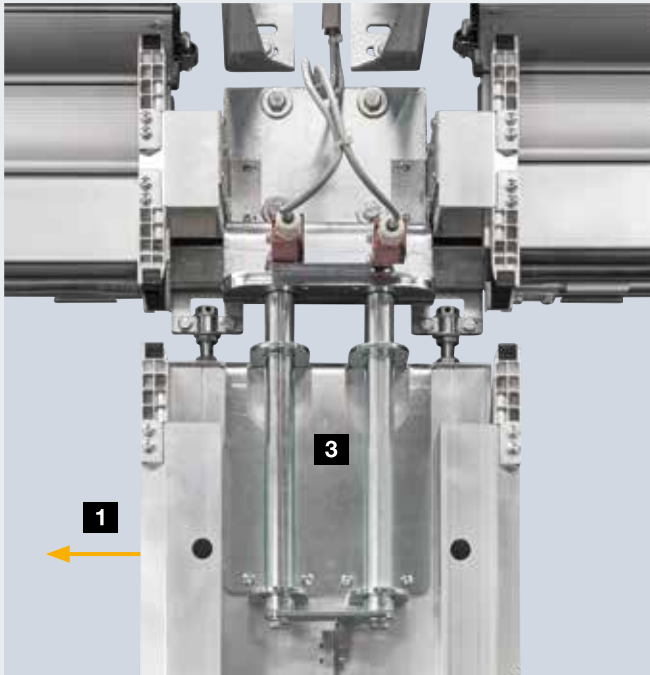

## Details

- Can be quickly and easily moved sideways thanks to a low-friction track behind the lintel **1**
- No components swivelling inwards or outwards
- Narrow mullion made of aluminium with a width of only 375 mm
- Swivel mechanism **2** with function monitoring prevents door travel when SSG DD is unlocked
- Robust bolts at the lintel and floor for secure closing and reliable transmission of wind loads **3**
- Viewed from outside in bright-rolled aluminium with line design **4** as standard, optionally with profile configuration matching the door curtain **5**





## Rolling shutter DD S6

Fast and secure with soft start and soft stop



The rolling shutter DD S6 is characterised by fast door opening for doors **up to 7500 mm width and 8500 mm height.**



High opening and closing speeds of **up to 1.1 m/s** optimise door operation and reduce heat loss.



The standard light grille at the side guides reduces the risk of collisions with forklifts.

# Rolling shutter DD S6

Optimises the flow of traffic and reduces energy loss



## Quick door opening

With the optional accessory package S6, the rolling shutter DD with Decotherm curtain opens at up to 1.1 m/s – almost as fast as a high-speed door.

## Economical door system

This door / operator solution is characterised by significantly smaller fitting dimensions as well as lower procurement and operating costs compared to a high-speed door. For a longer overall service life, the door construction is designed for 200000 door cycles\* (Open / Close).

## Secure monitoring

The operator with soft start and soft stop function ensures gentle door travel. The standard safety light grille monitors the closing zone of the door up to a height of 2500 mm and stops the door without contact in the event of obstacles.

\* With regular maintenance replacement of wearing parts



## Curtain variant rolling shutter DD

### Size range

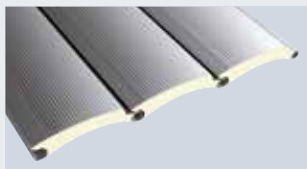

### Decotherm S, steel

Maximum door width 7500 mm,  
Maximum door height 8500 mm,  
Minimum door height 2750 mm

Curtain with wind locks as standard.  
For further information, see page 45.

Curtain overview from page 40



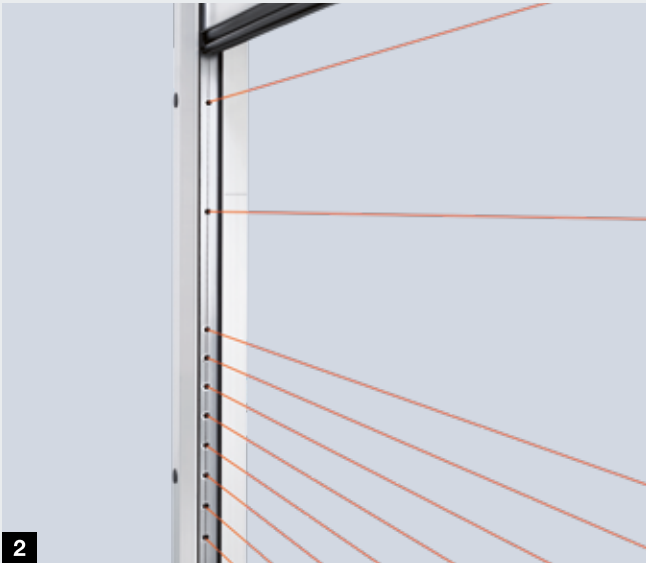

**Optional accessory package S6  
Fast, secure and reliable  
with soft start and soft stop**

- For rolling shutter DD with Decotherm S curtain
- Powerful 1-phase FU operator (230 V 1-phase current, 50 Hz) with soft start and soft stop for gentle door travel **1**
- Up to 30 door cycles per hour or 300 per day
- Light grilles in the side guides safeguard the door area even with high closing speeds **2**
- Wear-free monitoring of the door operation as no sensors are required on the curtain
- L-Pads on the inside of the curtain to minimise noise and wear **3**
- Space-saving design with only 100 mm of additional required headroom compared to a standard version rolling shutter DD **4**
- Optionally with window profiles



# Rolling shutter laths

Double- and single-skinned





# Rolling shutter laths

## Decotherm S, HR 120 A, HR 120 aero

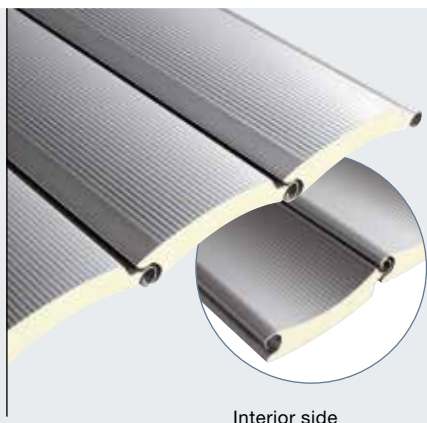

Interior side



Interior side



Interior side

### Decotherm S, steel

The profile made of galvanized special steel with barrel-optimised geometry is especially resistant to damage caused by transport, fitting and operation. The curtain is optionally available with or without colour coating.

Lined profile view on interior and exterior, optionally with colour coating in RAL to choose on both sides.

### HR 120 A, aluminium

The HR 120 A profile is the ideal solution for unheated buildings. The bright-rolled version is the standard surface finish for this profile. The profile exterior of the coil-coated surface finish features high-quality colour coating.

Interior in Basalt grey, RAL 7012, if colour-coated to choose.

### HR 120 aero, aluminium

This finely perforated profile permits the entry of adequate light and air. Leaves, paper and other contaminants remain outside. The bright-rolled surface finish is particularly well-suited for simple applications without requirements to appearance. The exterior of the coil-coated surface finish features a high-quality colour coating.

Interior in Basalt grey, RAL 7012, if colour-coated to choose.

Profile type	Decotherm S	HR 120 A	HR 120 aero
<b>Material</b>	Steel	Aluminium	Aluminium
<b>Surfaces without colour coating</b>	Galvanized without protective paint*	Bright-rolled without protective paint	Bright-rolled without protective paint
<b>Surfaces with colour coating</b>	Exterior and interior with identical colour coating to choose	Exterior: Colour coating to choose Interior: Basalt grey protective paint, RAL 7012	Exterior: Colour coating to choose Interior: Basalt grey protective paint, RAL 7012
<b>Standard colours</b>	RAL 9002 RAL 9006	RAL 9002 RAL 9006	RAL 9002 RAL 9006
<b>Preferred colours**</b>	•	•	–
<b>Special colours</b>	•	•	–
<b>Profile height</b>	109 mm	119 mm	119 mm
<b>Curtain weight</b>	Approx. 10.3 kg/m <sup>2</sup>	Approx. 6.0 kg/m <sup>2</sup>	Approx. 5.5 kg/m <sup>2</sup>
<b>Wind load class 2 up to a door width of</b>	12000 mm	7500 mm	5500 mm
<b>Heat transmission EN 12428 (single profiles)</b>	3.9 W/(m <sup>2</sup> ·K)	–	–
<b>Ventilation cross section</b>	–	–	Approx. 30 %
<b>Door type</b>	Rolling shutter SB Rolling shutter TGT Rolling shutter DD	Rolling shutter SB Rolling shutter DD	Rolling shutter SB Rolling shutter DD
<b>Windows</b>	•	•	–
<b>Ventilation laths</b>	–	•••	–

\* Differences in appearance between two doors may occur for technical reasons

\*\* For preferred colours, see page 49

\*\*\*Ventilation laths HR 120 aero

- Optionally available
- Not available

All colours based on RAL

**All SB, TGT, DD rolling shutter curtains are supplied as standard with wind locks or pull-out protection. For further information, see page 45.**



# Rolling grille curtains

HG-V, HG-S, HG-L



## HG-V, aluminium (reinforced)

The aluminium curtain reinforced with V2 A stainless steel honeycomb connections is ideal for wide openings in underground garages or multi-storey car parks where high numbers of opening / closing cycles are required.



## HG-S, steel

The galvanized steel version is robust and inexpensive. The curtain is also available with colour coating to choose.

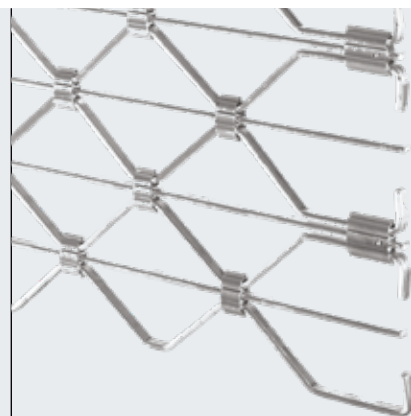

## HG-L, aluminium

The elegant and space-saving aluminium version is particularly suitable for use in collective garages and shopping arcades. Grille and honeycomb connections with aluminium crossbars provide protection to exclude the possibility of reaching through.

Curtain type	HG-V	HG-S	HG-L
Material	Aluminium	Steel	Aluminium
Surfaces without colour coating	Bright-rolled	Galvanized	Bright-rolled
Surfaces with colour coating	-	Colour coating to choose	Colour coating to choose or anodised in a natural finish (E6 / EV 1)
Weight of curtain	Approx. 7 kg/m <sup>2</sup>	Approx. 14 kg/m <sup>2</sup>	Approx. 6.5 kg/m <sup>2</sup>
Ventilation cross section	Approx. 85 %	Approx. 85 %	Approx. 77 %
Door type	Rolling grille DD	Rolling grille DD	Rolling grille SB Rolling grille TGT Rolling grille DD

*The curtains for rolling grilles SB, TGT, DD are supplied as standard with wind locks or pull-out protection. For further information, see page 45.*

# Shop doors

Compact fitting dimensions and tested security



## Shop door ShopRoller SR

The elegant shop door with curtain, side guide and bottom profile made of anodised aluminium E6 / EV 1 fits unobtrusively into the fitting environment. Four curtain versions and tested RC 2 / RC 3 curtain variants offer an individual view and break-in-resistant security.

RC2

RC3

## Sliding door RC 2 security combination with rolling grille HG 75 TD

The combination of the rolling grille HG 75 TD with the sliding door AD 100 combines the requirements of a convenient automated daytime entrance door and escape route as well as a secure night door. This combination meets the RC 2 requirement (tested and approved) when the door and grille are closed.

RC2



NEW: Shop door ShopRoller SR



Automatik-Türsysteme

More information can be found in the "Shop door ShopRoller SR" and "Automatic door systems" brochures.

# Wind lock and break-in resistance

For a sturdy and safe operation





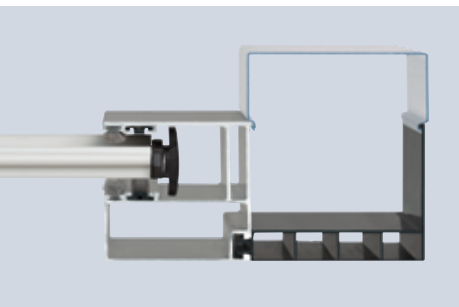

Rolling shutter SB / TGT profile  
Decotherm S with plastic wind lock

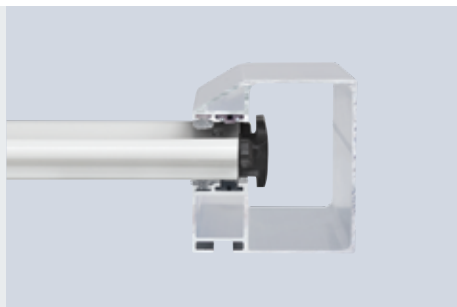

Rolling shutter DD profile Decotherm S  
with plastic wind lock

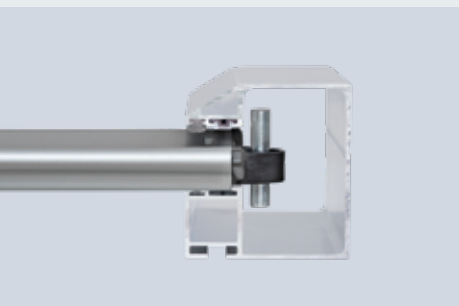

Rolling shutter DD profile Decotherm S  
with steel wind lock (from 7500 mm door  
width or height or optionally higher wind  
load requirements)



Rolling grille curtains HG-V, HG-S and  
HG-L with pull-out protection (rolling  
grille DD with curtain HG-L shown)

## Wind locks and pull-out protection

All rolling shutter and rolling grille curtains for door types SB, TGT and DD are supplied as standard with wind locks or pull-out protection. These prevent the curtain from being pushed out of the side guides by wind loads or burglars.



Shootbolt for rolling shutter /  
rolling grille SB



Shootbolt for rolling shutter /  
rolling grille DD

## Shootbolt for rolling shutter / rolling grille SB

The shootbolts are fitted on the interior on the right and left end of the bottom profile (not suitable for external rolling shutters).

## Shootbolt for rolling shutter / rolling grille DD

The shootbolt can be fitted to the right or left of the side guide. The lock can be secured with a padlock (not suitable for external rolling shutters).



Lockable bottom profile outside view



Lockable bottom profile inside view

## Lockable bottom profile with profile cylinder for all door types

Actuation either from the interior and exterior or only from the interior.

# Side doors and fascia panels

## Matching the door



### Side door NT 60 R

- For all rolling shutter and rolling grille curtains
- 60 mm aluminium frame construction
- As standard with all-round seals made of long-lasting, weather-resistant EPDM
- Two-part hinges, three-way adjustable
- Curtains fixed by glazing beads
- Also available with a fascia panel

### Fittings

- Mortice lock with profile cylinder
- Offset lever handle set with oval rose escutcheons, made of black plastic
- On request also available as lever / knob handle sets
- Optionally available in natural finish cast aluminium, polished stainless steel or brushed stainless steel

### Optional equipment

- Stainless steel push bar 38-2, brushed, 1000 mm high, outside, additionally with stainless steel lever handle set, inside
- Overhead door closer with hold-open device
- Push bar for escape door, inside (panic lock required)
- Multiple-point locking
- Window section with synthetic double pane



Side door NT 60 R for rolling shutters viewed from outside



Viewed from inside with 3-way adjustable hinge



Viewed from inside with synthetic glazing



Lever handle set as standard

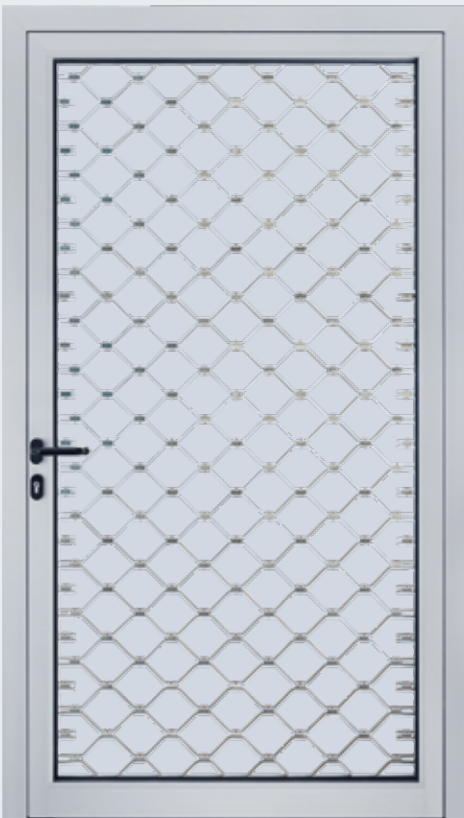

Side door NT 60 R for rolling grilles viewed from outside

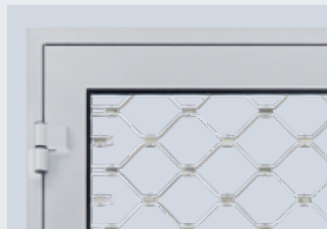

Viewed from inside with 3-way adjustable hinge



Lever handle set as standard



Optional additional synthetic pane to provide protection to exclude the possibility of reaching through



## Steel side doors with thermal break

### Multi-purpose door MZ Thermo 65

- 65-mm-thick door leaf with thermal break and PU rigid foam infill
- Aluminium block frame with thermal break and threshold with thermal break
- High thermal insulation with a U value = 0.82 W/(m<sup>2</sup>·K)
- Optionally available in a RC 2 KSI Thermo version with 42-mm-thick door leaf



For further information, see the "Steel doors" brochure.



# Coloured rolling shutters and rolling grilles

Create attractive accents



## Matching door colours for the facade

Coloured doors are increasingly used as design elements in modern industrial and commercial architecture. Due to their size alone, industrial rolling shutters and rolling grilles already play a key role in determining the visual appearance of the facade. This is why Hörmann offers you high-quality curtain coatings in more than 1000 RAL colours.

## High-grade colour coating





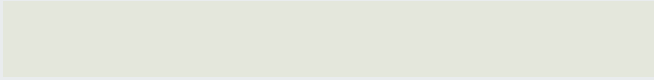
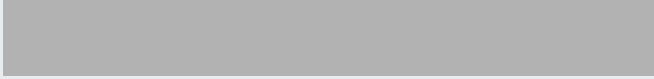

Coil-coated rolling shutter laths provide long-term protection against adverse weather effects for surface finishes. Additional protective paint with polyamide particles reduces abrasion and noise.

All curtain and door types feature a bright-rolled bottom profile.

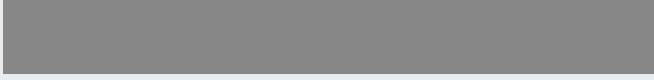
## Standard colours

	
Grey white	RAL 9002
	
White aluminium	RAL 9006

## Preferred colours\*

	
Traffic white**	RAL 9016
	
Grey aluminium	RAL 9007
	
Terra brown	RAL 8028
	
Anthracite grey	RAL 7016
	
Moss green	RAL 6005
	
Gentian blue	RAL 5010
	
Flame red	RAL 3000

\* Not for HR 120 aero

\*\* For Decotherm S

## Special colours according to RAL

The colours shown are subject to the limitations of the printing process and cannot be regarded as binding.

All colours based on RAL.

Slight colour variations are permissible.



# Rolling shutters and rolling grilles

At Hörmann, safety is certified for:

## Safety features in accordance with European standard 13241-1 Hörmann products are tested and certified for:

- Anti-fall safeguard
- Trap protection
- Trap guard

Hörmann rolling shutters and rolling grilles work safely during all opening and closing phases – whether manually-operated or power-driven.

In doors with an impulse control, the specified dynamic closing forces are reliably maintained through monitoring systems with an integrated self-test function.

At Hörmann, the door and operator are perfectly matched to each other, tested by independent organisations for your safety and in compliance with the relevant standards.

**It pays to compare!**

## Rolling grilles in public, easily accessible areas

Special safety equipment is required in areas frequented by children, who may hang on the rolling grille.

Lintel trap guards always need to be fitted on rolling grilles DD with impulse control.

With rolling grille TGT with operators WA 300 R S4 and WA 300 AR S4, the safety requirements according to DIN 13241-1 are fulfilled by the standard power limit in the “Open” direction.

## Performance characteristics according to European standard 13241-1 Hörmann products are tested and certified for:

- Thermal insulation
- Acoustic insulation
- Sealing
- Wind load





# Compatible system solutions

For high functional door safety



## Better with a system

This means the components have been optimally adjusted to work together, ensuring the door's functional safety.

The uniform operating concept of the control components and the 7-segment display facilitate everyday use. Fitting is also simplified thanks to uniform housings and cable sets. This way, all Hörmann products work together optimally and efficiently:

- Industrial doors
- Loading technology
- Operators
- Controls
- Accessories

# Controls

## Compatible system solutions



	Internal control WA 250 R S4	Internal control WA 300 R S4	External control 300	External control 360	Impulse control 445 R	
<b>Door type / operators</b>						
Rolling shutter / rolling grille SB with WA 250 R S4	●	–	–	–	–	
Rolling shutter / rolling grille SB / TGT with WA 300 R S4	–	●	–	○	–	
Rolling shutter / rolling grille SB / TGT with WA 300 AR S4	–	–	●	○	–	
Rolling shutter / rolling grille DD with direct drive operator	–	–	–	–	●	
Rolling shutter DD with accessory package S6	–	–	–	–	–	
<b>Functions / features</b>						
Control and operator can be mounted separately	–	–	●	●	●	
Adjustments made conveniently directly on the control	–	–	●	●	●	
Soft start and soft stop for quiet door travel	●	●	●	●	–	
Power limit in “Open” / “Close” directions <sup>4)</sup>	–	●	●	●	–	
Second opening height with additional button on the housing cover	–	○ <sup>2)</sup>	○ <sup>2)</sup>	●	–	
Status and error display via LED	●	●	●	–	–	
Menu reading from outside with an integrated double 7-segment display (maintenance, cycle and operating hours counter as well as error analysis)	–	–	–	●	●	
Collective malfunction signaling with on-site individual display (acoustic, visual, or e.g. via mobile phone)	–	–	–	○	○	
Extension possible with external radio receiver	–	●	●	●	●	
Automatic timer <sup>1)</sup>	–	●	●	●	–	
Traffic control <sup>1)</sup>	–	–	–	○	–	
Integrated connecting terminals for additional command units	–	●	●	●	●	
Function lock via miniature lock	○	○	●	● <sup>5)</sup>	● <sup>5)</sup>	
Without closing edge safety device SKS: “Open” / “Close” in press-and-release operation <sup>4)</sup>	–	●	●	●	–	
Standard accessory DTH-R push button	●	●	–	–	–	
<b>Power supply</b>						
Power supply	230 V	230 V	230 V	230 V	400 / 230 V	
Main switch integrated into control housing	○ <sup>3)</sup>	○ <sup>3)</sup>	○	○	○	
Protection category IP 65 (jet-water protected) for control and door leaf components	●	●	●	●	●	

● As standard

○ With corresponding equipment possibly with additional control

– Not available

<sup>1)</sup> Only in combination with an activating kit for warning light and photocell or light grille

<sup>2)</sup> Possible in combination with UAP1-300 and DTH I or DTH IM

<sup>3)</sup> In combination with push button control 300 U

<sup>4)</sup> In the “Close” direction, the power limit is only possible in the indicated curtain variants and size ranges (see “Impulse operation without closing edge safety device”, see page 17)

<sup>5)</sup> Convertible to profile half cylinder



**Comfort control  
460 R**

**FU control  
B 971 R S6**

	-	-
	-	-
	-	-
	○	-
	-	●
	●	●
	●	●
	-	●
	-	-
	●	-
	-	-
	●	●
	○	○
	●	●
	●	●
	○	-
	●	●
	● <sup>5)</sup>	● <sup>5)</sup>
	-	-
	-	-
	400 / 230 V	230 V
	○	○
	●	●



**Optional: Profile half cylinder**  
For all external controls  
(except control 300)



**Optional: Main switch**  
For all external controls



**Combination control 420 Si / 420 Ti**

This solution combines door operation with operator WA 300 R S4 / WA 300 AR S4 with a standard dock leveller control in one housing.

The advantages:

- Easy to fit
- Inexpensive
- Compact
- Suitable for hinged lip (420 Si) and telescopic lip dock levellers (420 Ti)
- Optionally: Integration of "Open" limit switch reporting for dock leveller release



**Optionally: Key switch post STI 1**

For installing a maximum of 2 controls with additional housing,  
Colour: White aluminium, RAL 9006,  
Dimensions: 200 x 60 mm, height 1660 mm

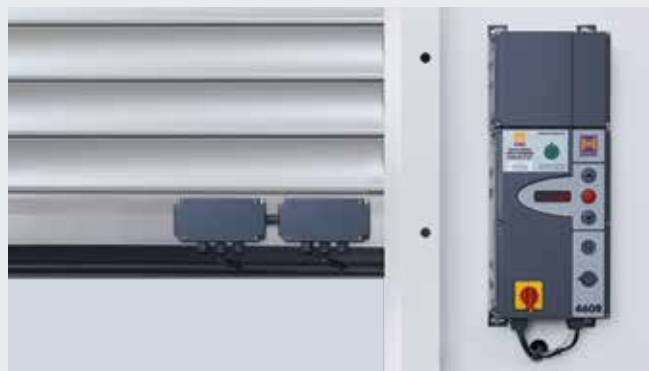

**Radio transmission unit**

Optional equipment for transmission of signals from the door curtain to the control via Bluetooth – instead of a coiled cable. Power supply via a high-performance battery. For controls: 445 R / 460 R



### For smoke extraction concepts with industrial doors

Smoke and heat extraction systems are an essential part of preventive fire protection and personal safety. In the event of fire, windows and transom lights in the facade and ceiling area are opened, allowing smoke and fumes to be discharged from the building. At the same time, fresh air is supplied from below via building openings such as inlet flaps in the building facade.

Thanks to the new air inlet control AC72, door systems can be integrated in smoke extraction concepts to securely supply fresh air. When the fire alarm system is triggered, the AC72 automatically transmits the impulse to open the door to the minimum required opening height within 60 seconds. Additionally, the AC72 complies with the general requirements for smoke extraction systems, such as monitored battery operation in case of power failure for 72 hours. By integrating industrial doors into the smoke extraction concept of your building, you can reduce investment and fitting costs of additional ventilation flaps and improve the thermal insulation of the building, as fewer doors have to be integrated into the facade.



### RWA smoke and heat extraction

- Smoke extraction in the event of fire thanks to a robust, low-smoke layer near the floor (by using targeted air supply)
- To ensure escape and rescue routes

### Qualified smoke extraction systems approved in accordance with 12101-2 and dimensioned according to DIN 18232-2

- Required by building regulations (e.g. in assembly areas and industrial buildings)
- For building permits considering additional protective goals (e.g. property protection requirements by operator or insurance company)

### Protective goals

- Support fire brigades in fire-fighting
- Personal safety
- Protection of production systems
- Protection of goods and raw materials
- Protection of building



## Industrial buildings

### Operator / control combinations with the AC72:

- Operator WA 300 R S4 with control 300 U
- Operator WA 300 AR S4 with control 300



## Logistics buildings

### Operator / control combinations with the AC72:

- Operator WA 300 R S4 with control 420 Si / 420 Ti



# Accessories

## Radio control, receivers

**Only from Hörmann**

### Hörmann BiSecur (BS)

#### The modern radio system for industrial door operators

The bi-directional radio system BiSecur is based on future-oriented technology for the convenient and secure operation of industrial doors. The extremely secure BiSecur encryption protocol makes sure that no one can copy your radio signal. It was tested and certified by security experts at Bochum university.

#### Your advantages

- 128-bit encryption with the same high security level as online banking
- Interference-resistant radio signal with a stable range
- Convenient querying of the door position\*
- Backwards compatible, i.e. radio receivers with the frequency 868 MHz (2005 to June 2012) can also be operated with BiSecur control elements.



#### 5-button hand transmitter HS 5 BS

With additional button for querying the door position\*, high-gloss black or white, with chrome caps

#### 5-button hand transmitter HS 5 BS

With additional button for querying the door position\*, black textured surface, with chrome caps

#### 4-button hand transmitter HS 4 BS

Black textured surface with chrome caps

#### 1-button hand transmitter HS 1 BS

Black textured surface with chrome caps



#### 4-button security hand transmitter HSS 4 BS

Additional function: copy protection for hand transmitter coding, with chrome caps

#### 2-button hand transmitter HSE 2 BS

High-gloss black or white, with chrome caps

#### 4-button hand transmitter HSE 4 BS

Black textured surface with chrome or plastic caps

#### 1-button hand transmitter HSE 1 BS

Black textured surface with chrome caps

\* For WA 300 S4 or control 300 with optional bi-directional receiver ESEi BS, for all other operators with optional bi-directional receiver HET-E2 24 BS and end-of-travel position feedback





**Industrial hand transmitter  
HSI 6 BS, HSI 15 BS**

To control up to 6 doors (HSI 6 BS) or 15 doors (HSI 15 BS), with extra-large buttons for easier operation with work gloves, impact-resistant housing  
Protection category: IP 65



**Radio code switch  
FCT 3-1 BS // NEW**

For 3 functions, with illuminated buttons, recessed and surface-mounted fitting possible



**Radio code switch  
FCT 10-1 BS // NEW**

For 10 functions, with illuminated buttons and hinged cover, recessed and surface-mounted fitting possible



**Radio finger-scan  
FFL 25 BS // NEW**

For 2 functions, up to 25 fingerprints, with hinged cover, recessed and surface-mounted fitting possible



**Industrial hand transmitter  
HSI BS**

To control up to 1000 doors, with a display and extra-large quick selection buttons for easier operation with work gloves, transferring of hand transmitter coding to other devices possible



**Radio radar button FSR 1 BS**

Sensor for non-contact opening, plastic housing, IP 41  
For recessed and surface-mounted fitting



**3-channel receiver  
HEI 3 BS**

For controlling 3 functions



**Bi-directional receiver  
ESEi BS**

For querying the door position



**1-channel relay receiver  
HER 1 BS**

With volt-free relay output with status query



**2-channel relay receiver  
HER 2 BS**

With 2 volt-free relay outputs with status query and external antenna



**2-channel relay receiver  
HET-E2 24 BS**

With 2 volt-free relay outputs for choosing the direction, a 2-pin input for volt-free "Open" and "Close" limit switch reporting (for querying the door position)



**4-channel relay receiver  
HER 4 BS**

With 4 volt-free relay outputs with status query



# Accessories

## Push buttons



### Push button DTH R

For separate control of both operational directions, with separate stop button

Dimensions:  
90 × 160 × 55 mm (W × H × D)  
Protection category: IP 65

**For controls:**  
**300, 360, 445 R, 460 R and integrated controls WA 250 R S4, WA 300 R S4**



### Push button DTH RM

For separate control of both operational directions, with separate stop button, with miniature lock: Control of the operator is deactivated. The operator can no longer be actuated. (2 keys included in the scope of delivery)

Dimensions:  
90 × 160 × 55 mm (W × H × D),  
protection category: IP 65

**For controls:**  
**300, 360, 445 R, 460 R and integrated controls WA 250 R S4, WA 300 R S4**



### Push button DTH I

To move the door into the Open / Close positions, separate stop button to stop door travel, 1/2-Open button\* to open the door up to the programmed intermediate travel limit

Dimensions:  
90 × 160 × 55 mm (W × H × D)  
Protection category: IP 65

**For controls:**  
**300, 360, 460 R and integrated control WA 300 R S4**



### Push button DTH IM

To move the door into the Open / Close positions, separate stop button to stop door travel, 1/2-Open button to open the door up to the programmed intermediate travel limit, with miniature lock: Operator control is deactivated. The operator can no longer be actuated. (2 keys included in the scope of delivery)

Dimensions:  
90 × 160 × 55 mm (W × H × D),  
protection category: IP 65

**For controls:**  
**300, 360, 460 R and integrated control WA 300 R S4**



### Push button DT 02

Open or close via a command button, separate stop button

Dimensions:  
75 × 145 × 70 mm (W × H × D)  
Protection category: IP 65

**For controls:**  
**360, 445 R and 460 R**



### Push button DT 03

For separate control of both operational directions, with separate stop button

Dimensions:  
75 × 180 × 70 mm (W × H × D)  
Protection category: IP 65

**For controls:**  
**360, 445 R and 460 R**



### Push button DT 04

For separate control of both operational directions, with separate stop button, full or partial door opening (via a separate button)

Dimensions:  
75 × 225 × 70 mm (W × H × D)  
Protection category: IP 65

**For controls:**  
**360 and 460 R**



### Push button DTN A 30

For separate control of both operational directions. The stop button is a push-to-lock button which, once pressed, stays depressed in order to prevent unauthorised operation. Subsequent actuation is then only possible once the stop button has been unlocked with a key (2 keys included in the scope of delivery).

Dimensions:  
75 × 180 × 105 mm (W × H × D)  
Protection category: IP 65

**For controls:**  
**360, 445 R and 460 R**

\* The function of the controls 300 and WA 300 R is only possible in conjunction with a UAP 1-300

# Accessories

## Push buttons, key switches, key switch posts



### Push button DTP 02

Open or close via a command button, separate stop button and operation control light for control voltage, lockable with profile half cylinder (available as an accessory)

Dimensions:  
77 x 235 x 70 mm (W x H x D)  
protection category: IP 44

**For controls:**  
300, 360, 445 R, 460 R and  
integrated control WA 300 R S4



### Push button DTP 03

For separate control of both operational directions, separate stop button and operation control light for control voltage, lockable with profile half cylinder (available as an accessory)

Dimensions:  
77 x 270 x 70 mm (W x H x D)  
protection category: IP 44

**For controls:**  
300, 360, 445 R, 460 R and  
integrated controls WA 250 R S4,  
WA 300 R S4



### Emergency-off button DTN 10

To quickly immobilise the door system, push-to-lock button (mushroom button), surface-mounted,

Dimensions:  
93 x 93 x 95 mm (W x H x D)  
Protection category: IP 65

**For controls:**  
300, 360, 445 R, 460 R and  
integrated controls WA 250 R S4,  
WA 300 R S4



### Emergency-off button DTNG 10

To quickly immobilise the door system, push-to-lock mushroom button, surface-mounted,

Dimensions:  
93 x 93 x 95 mm (W x H x D)

Protection category: IP 65

**For controls:**  
300, 360, 445 R, 460 R and  
integrated controls WA 250 R S4,  
WA 300 R S4

The lockable function serves to isolate the control voltage and immobilises the command units. Profile half cylinders are not included in the scope of delivery for the push buttons.



### Key switch ESU 30 with 3 keys

Recessed version, Impulse or Open / Close functions selectable  
Dimensions of the switch box:

60 mm (d), 58 mm (D)

Dimensions of the cover:

90 x 100 mm (W x H),

Brickwork recess:

65 mm (d), 60 mm (D)

Protection category: IP 54

Surface-mounted version ESA 30  
(not shown)

Dimensions:

73 x 73 x 50 mm (W x H x D)



### Key switch STAP 50 with 3 keys

Surface-mounted version

Dimensions:

80 x 80 x 63 mm (W x H x D)

Protection category: IP 54

### Key switch STUP 50 with 3 keys

Recessed version (not shown)

Dimensions:

80 x 80 mm (W x H),

Protection category: IP 54



### Pull switch ZT 2 with cord

Impulse transmission to open or close the door

Dimensions:

60 x 90 x 55 mm (W x H x D)

pull cord length: 3.2 m,

Protection category: IP 65

### Cantilever arm KA1 (not shown)

Extension 1680 – 3080 mm,

can be used with ZT 2



### Key switch posts

With a screw base for fitting to the floor, surface finish in White aluminium RAL 9006, 90 x 90 mm tube, also available as a set-in-concrete version

### Key switch post STN 1

To hold 1 command unit on the surface, height 1050 mm

### Key switch post STN 1-1

To hold 2 command units or 1 command unit and 1 warning light, height 1200 mm

**For command units:**  
CTR 1b-1, CTR 3b-1, CTV 3-1,  
CTP 3-1, TTR 1000-1, FL 150,  
STUP 50, HLA 1, dual LED  
warning light red / green



# Accessories

## Code switch, Bluetooth receiver



**Code switch CTR 1b-1, CTR 3b-1**  
For 1 (CTR 1b-1) or 3 (CTR 3b-1) functions, with illuminated buttons

Dimensions:  
80 × 80 × 15 mm (W × H × D)



**Code switch CTV 3-1**  
For 3 functions, with particularly robust metal keypad

Dimensions:  
80 × 80 × 15 mm (W × H × D)



**Code switch CTP 3**  
For 3 functions, with illuminated lettering and touch-sensitive surface

Dimensions:  
80 × 80 × 15 mm (W × H × D)



**Decoder housing**  
For code switch CTR 1b-1, CTR 3b-1, CTV 3-1, CTP 3

Dimensions:  
140 × 130 × 50 mm (W × H × D)  
switching capacity: 2.5 A / 30 V DC  
500 W / 250 V AC



**Finger-scan FL 150**  
For 2 functions,  
Can store up to 150 fingerprints

Dimensions:  
80 × 80 × 13 mm (W × H × D)  
decoder housing:  
70 × 275 × 50 mm (W × H × D)  
switching capacity: 2.0 A / 30 V DC



**Radar movement detector RBM 2**

For "Open door" impulse with directional recognition  
Max. fitting height: 6 m

Dimensions:  
155 × 132 × 58 mm (W × H × D)  
contact load:  
24 AC/DC, 1 A (resistivity),  
Protection category: IP 65

Optional remote control for radar movement detector



**Transponder key switch TTR 1000-1**  
For 1 function via transponder key or transponder card, up to 1000 keys or cards can be saved

Dimensions:  
80 × 80 × 15 mm (W × H × D)  
decoder housing:  
140 × 130 × 50 mm (W × H × D)  
switching capacity: 2.5 A / 30 V DC  
500 W / 250 V AC



**Bluetooth receiver HET-BLE**  
For operation, impulse control of industrial sectional doors via the Hörmann BlueSecur app

Dimensions:  
110 × 45 × 40 mm (W × H × D)



**UAP 1-300**  
For WA 300 R S4 or control 300  
For impulse selection, partial opening function, limit switch reporting and activating kit for warning lights with 2 m system cable

Dimensions:  
150 × 70 × 52 mm (W × H × D), max.  
switching capacity:  
30 V DC / 2.5 A (resistivity),  
250 V AC / 500 W (resistivity),  
Protection category: IP 65



**HOR 1-300**  
For WA 250 R S4, WA 300 R S4 or control 300  
To control limit switch reporting or warning lights with 2 m connecting lead

Dimensions:  
110 × 45 × 40 mm (W × H × D)  
Max. switching capacity:  
30 V DC / 2.5 A (resistivity),  
250 V AC / 500 W (resistivity),  
protection category: IP 44

Optionally available for integration into the push button control 300 U (not shown)

# Accessories

## Photocells, light grilles



### Reflection photocell RL 50 / RL 300

Photocell with transmitter / receiver unit and reflector  
The photocell is tested by the control prior to each closing cycle.  
Connected via a system cable (RL 50, length 2 m) or a 2-wire cable (RL 300, length 10 m).

Dimensions: 45 × 86 × 39 mm (W × H × D),  
protection category: IP 65,  
reflector range up to 8 m (standard): 30 × 60 mm (W × H),  
reflector range up to 12 m (not shown): 80 mm diameter;  
optionally: weather protective cover (not shown), anti-fog coating

### One-way photocell EL 51

Photocell with separate transmitter and receiver  
The photocell is tested by the control prior to each closing cycle.  
Connected via a system cable  
Max. range 8.0 m

Dimensions with fitting bracket:  
45 × 85 × 31 mm (W × H × D)  
Protection category: IP 65,  
optionally: weather protective cover (not shown)

### Light grille HLG-V as advance protection

The light grille additionally monitors the main closing edge of the door at a height of 2500 mm. Fitting is possible both on the outside of the facade and in the reveal as well as to the side guide. Optionally, the HLG-V can also be integrated into the key switch post set STL made of weather-resistant anodised aluminium.

Max. range: 10 m,  
protection category: IP 65,  
operating temperature: -20 °C to +60 °C,  
resolution: < 50 mm (below 500 mm);  
< 200 mm (over 500 mm),  
Increased security with cross-beam sensor technology, easy alignment possible,  
connecting leads included in the scope of delivery



Fitting in the reveal



Fitting to the side guide

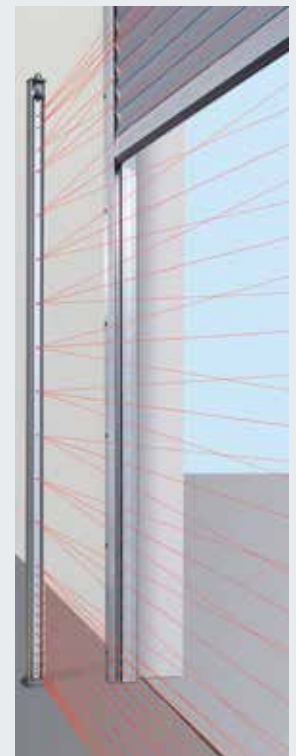

Fitting with key switch post set STL

# Accessories

## Activating kits, LED warning lights



**Multi-function circuit board to be fitted in an existing housing or optionally in a separate extension housing (shown)**  
Limit switch reporting, momentary impulse, collective malfunction signalling, extension unit for controls 360, 445 R, 460 R

Dimensions of additional housing:  
202 × 164 × 130 mm (W × H × D)  
Protection category: IP 65

A circuit board can be optionally mounted in the control.



**Digital weekly timer in a separate additional housing**  
The timer can switch command units on and off via a volt-free contact. Extension unit for controls 360, 445 R, 460 R (no additional housing, for fitting in an existing housing), switching capacity: 230 V AC, 2.5 A / 500 W, can be switched over to summer / winter time, manual switching: automatic operation, switching preselection "permanently ON / OFF"

Dimensions of additional housing:  
202 × 164 × 130 mm (W × H × D)  
Protection category: IP 65



**Summer / winter activating kit in additional housing**  
Function for full door opening and individually programmable intermediate travel limit, extension unit for controls 360, 445 R, 460 R

Dimensions of additional housing:  
202 × 164 × 130 mm (W × H × D)  
Protection category: IP 65



**Induction loop DI 1 in a separate additional housing**  
Suitable for one induction loop, detector with a normally open contact and a change-over contact

**Induction loop DI 2 (not shown) in a separate additional housing**  
Suitable for two separate induction loops, detector with two potential-free closing contacts, can be set for impulse or permanent contact, directional recognition possible

Dimensions of additional housing:  
202 × 164 × 130 mm (W × H × D)  
Switching capacity:  
DI 1: low voltage 2 A, 125 V A / 60 W,  
DI 2: 250 V AC, 4 A, 1000 VA (resistive load AC)  
Supplied without loop cable

Loop cable for induction loop: 50 m roll,  
cable designation: SIAF, cross-section: 1.5 mm<sup>2</sup>,  
colour: brown





**Activating kit for warning lights for fitting in an existing housing or optionally in a separate extension housing (shown),**

incl. 2 yellow LED warning lights TL40S **2**  
 Extension unit for control 360, 445 R, 460 R, with activating kit for warning lights as a visual indicator during door travel (weekly timer, optionally for 360, 445 R, 460 R), applications: approach warning (for 360, 445 R, 460 R), automatic timer (for 360, 460 R)

After the set hold-open phase has elapsed (0–480 s), the warning lights flash during the set pre-warning phase (0–70 s).

Dimensions of additional housing: 202 × 164 × 130 mm (W × H × D), contact load: 250 V AC: 2.5 A / 500 W, protection category: IP 65

**Traffic control in a separate additional housing (460 R) or for fitting in an existing housing (360)**

incl. 2 red / green LED warning lights TL40S **4**  
 or 2 red / yellow\* / green LED warning lights TL40S **5**  
 Extension unit for control 360, 460 R, with activating kit for warning lights as a visual indicator for regulating the entrance and exit (optional weekly timer), duration of the green phase: adjustable from 0–480 s, duration of the clearance phase: adjustable from 0–70 s

Dimensions of additional housing: 202 × 164 × 130 mm (W × H × D), contact load: 250 V AC: 2.5 A / 500 W, protection category: IP 65

\* Yellow is not required for traffic control

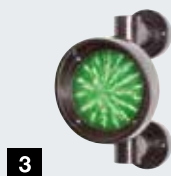

**1**  
**Red LED warning light TL40S**  
 1-arm red  
 (230 V / 50 Hz)

Traffic light dimensions:  
 180 × 250 × 290 mm  
 (W × H × D),

**2**  
**Yellow LED warning light TL40S**  
 1-arm yellow  
 (230 V / 50 Hz)

Traffic light dimensions:  
 180 × 250 × 290 mm  
 (W × H × D),

**3**  
**Green LED warning light TL40S**  
 1-arm green  
 (230 V / 50 Hz)

Traffic light dimensions:  
 180 × 250 × 290 mm  
 (W × H × D),

**4**  
**Red / green LED warning light TL40S**  
 2-arm red / green  
 (230 V / 50 Hz)

Traffic light dimensions:  
 180 × 410 × 290 mm  
 (W × H × D),

**5**  
**Red / yellow / green LED warning light TL40S**  
**// NEW**  
 1-arm red / yellow / green  
 (24 V DC)

Traffic light dimensions:  
 180 × 250 × 290 mm  
 (W × H × D),

# Performance characteristics

● = Standard

○ = Optional

		Rolling shutter SB			Rolling grille SB
		Decotherm	HR 120		HG-L
			S	A	aero
Wind load EN 12424	Class 2 up to door width in mm	5000	5000	4000	–
	Higher wind loads on request	–	–	–	–
	Wind locks	●	●	●	–
Water tightness EN 12425		0	0	0	0
Thermal insulation	Appendix B EN 12428 Individual door section (U = W/(m <sup>2</sup> ·K))	3,9	–	–	–
	Shutter 4 × 4 m, fitted (U = W/(m <sup>2</sup> ·K))	4,1	–	–	–
Acoustic rating	Shutter 3.5 × 2 m, fitted (R <sub>w</sub> = dB)	18	–	–	–
Door sizes	Max. width in mm	5000	5000	4000	6000
	Max. height in mm	4500	4500	4000	4500
Space requirements	See the technical manual				
Door curtain material	Single-skinned steel	–	–	–	–
	Double-skinned steel	●	–	–	–
	Single-skinned aluminium	–	●	●	●
	Double-skinned aluminium	–	–	–	–
Door curtain surface finish	Galvanized steel	●	–	–	–
	Galvanized steel coated in RAL 9002	○	–	–	–
	Galvanized steel coated in RAL 9006	○	–	–	–
	Galvanized steel coated in RAL to choose	○	–	–	–
	Bright-rolled aluminium	–	●	●	–
	Stucco-textured aluminium	–	–	–	–
	Aluminium coated in RAL 9002	–	○	○	○
	Aluminium coated in RAL 9006	–	○	○	○
	Aluminium coated in RAL to choose	–	○	–	○
	Anodised aluminium E6 / EV 1	–	–	–	○
	Mill-finished aluminium	–	–	–	●
Weight of door curtain	approx. kg/m <sup>2</sup>	10,3	6,0	5,5	6,5
Side door	matching the door	○	○	○	○
Glazing	Standard arrangement	○	○	–	–
	Logistics arrangement	○	○	–	–
Seals	All-round on 4 sides	○	○	–	–
Break-in resistance	WK 2 DIN V ENV 1627:1999	–	–	–	–
	Pull-out protection	●	●	●	●
	Internal locking	○	○	○	○
	Internal / external locking	○	○	○	○
Safety equipment	Finger trap protection	●	●	●	–
	Side trap guard	○	○	○	○
	Safety catch	●	●	●	●
Fastening options	Concrete	●	●	●	●
	Steel	●	●	●	●
	Brickwork	●	●	●	●
	Timber	●	●	●	●

\* RAL 9016, RAL 7035, RAL 9006, RAL 5011, RAL 8028, RAL 7016, RAL 9005

\*\* Shutter 4 × 2.4 m, fitted

	Rolling shutter / rolling grille TGT		Rolling shutter DD			Rolling grille DD		
	Decotherm	HG-L	Decotherm	HR 120		HG-V	HG-S	HG-L
	S		S	A	aero			
	5000	-	12000	7500	4500	-	-	-
	-	-	○	○	-	-	-	-
	●	●	●	●	●	-	-	-
	0	0	0	0	0	0	0	0
	3,9	-	3,9	-	-	-	-	-
	4.2**	-	4,1	-	-	-	-	-
	18	-	18	-	-	-	-	-
	5000	6000	12000	12000	12000	12000	12000	9000
	2400	2400	9000	8000	8000	8000	8000	5500
	-	-	-	-	-	-	●	-
	●	-	●	-	-	-	-	-
	-	●	-	●	●	●	-	●
	-	-	-	-	-	-	-	-
	●	-	●	-	-	-	●	-
	○	-	○	-	-	-	-	-
	○	-	○	-	-	-	-	-
	○	-	○	-	-	-	○	-
	-	-	-	●	●	●	-	-
	-	-	-	-	-	-	-	-
	-	○	-	○	○	-	-	-
	-	○	-	○	○	-	-	-
	-	○	-	○	-	-	-	○
	-	○	-	-	-	-	-	○
	-	●	-	-	-	-	-	●
	10,3	6,5	10,3	6,0	5,5	7,5	15	6,5
	○	○	○	○	○	○	○	○
	○	-	○	○	-	-	-	-
	○	-	○	○	-	-	-	-
	○	-	●	●	-	-	-	-
	-	-	-	-	-	-	-	-
	●	●	●	●	-	●	●	●
	○	○	○	○	○	○	○	○
	○	○	○	○	○	○	○	○
	●	-	●	●	●	-	-	-
	○	○	○	○	○	○	○	○
	●	●	●	●	●	●	●	●
	●	●	●	●	●	●	●	●
	●	●	●	●	●	●	●	●
	●	●	●	●	●	●	●	●
	●	●	●	●	●	●	●	●



# Hörmann Product Range

Everything from a single source for your construction project





**Quick service with testing, maintenance and repairs**  
Our extensive service network means that we are always nearby and at your service around the clock.

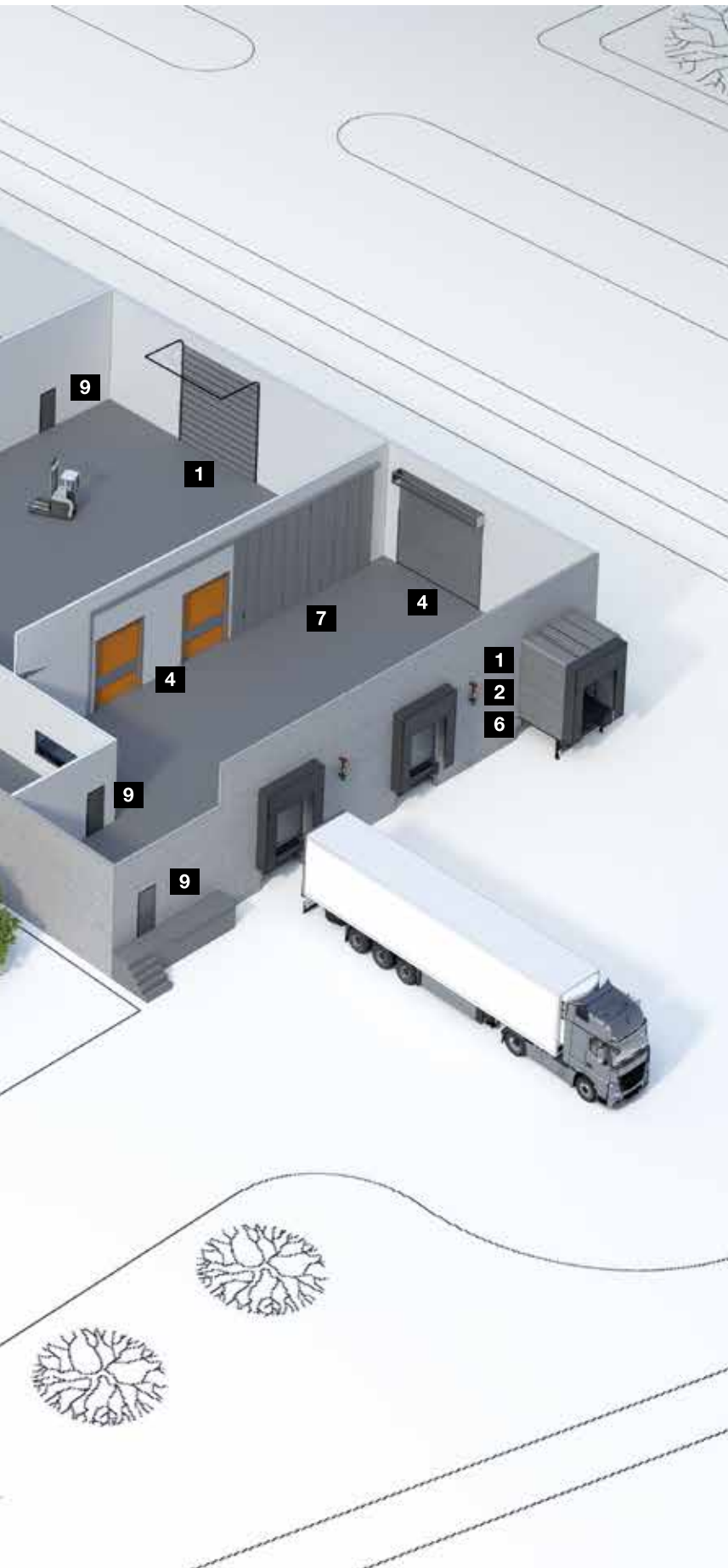

**1** Sectional doors



**2** Rolling shutters and rolling grilles



**3** Shop doors



**4** High-speed doors



**5** High-speed folding doors



**6** Loading technology



**7** Steel and stainless steel sliding doors



**8** Fire protection curtains



**9** Steel and stainless steel construction project doors



**10** Steel frames with high-quality timber function doors from Schörghuber



**11** Tubular frame construction project doors



**12** Automatic sliding doors



**13** Visibility window



**14** Collective garage doors



**15** Bollards and road blockers



**16** Barrier and pay station systems



# Hörmann: Quality without Compromise



Hörmann KG Amshausen, Germany



Hörmann KG Antriebstechnik, Germany



Hörmann KG Brandis, Germany



Hörmann KG Brockhagen, Germany



Hörmann KG Dissen, Germany



Hörmann KG Eckelhausen, Germany



Hörmann KG Freisen, Germany



Hörmann KG Ichtershausen, Germany



Hörmann KG Werne, Germany



Hörmann Alkmaar B.V., Netherlands



Hörmann Legnica Sp. z o.o., Poland



Hörmann Beijing, China



Hörmann Tianjin, China



Hörmann LLC, Montgomery IL, USA



Hörmann Flexon LLC, Burgettstown PA, USA



Shakti Hörmann Pvt. Ltd., India

Hörmann is the only manufacturer worldwide that offers you a complete range of all major building products from one source. We manufacture in highly-specialised factories using the latest production technologies. The close-meshed network of sales and service companies throughout Europe, and activities in the USA and Asia, make Hörmann your strong partner for first-class building products, offering “Quality without Compromise”.

**GARAGE DOORS**  
**OPERATORS**  
**INDUSTRIAL DOORS**  
**LOADING EQUIPMENT**  
**HINGED DOORS**  
**DOOR FRAMES**